

## Fits Virtually Entire Range of Immersion and Air Heating Applications

Available in single- or double-ended termination styles, the versatile and economical WATROD™ tubular heating element from Watlow® lends itself to virtually the entire range of immersion and air heating applications.

The single-ended WATROD tubular design has both terminals at one end. The opposite end is sealed. Flexible lead wires are 12 in. (305 mm) crimp connected to the terminal pin and have silicone-impregnated fiberglass oversleeves.

The double-ended WATROD, with its round cross-sectional geometry, is highly adaptable for bending—especially when bending is performed in the field. Watlow's double-ended MULTICOIL™ tubular elements offer various combinations of resistor coils and thermocouples inside one sheath. They have the ability to sense the heater's internal temperature accurately every time, or offer three-phase capability in one element.

Both single- and double-ended WATRODs share many construction features delivering long life—the resistance wire is centered in the heater sheath and electrically insulated with compacted, high-grade magnesium oxide for superior heating performance.

WATROD heating elements have a variety of mounting and termination options making them highly popular among industrial customers.

### Performance Capabilities

#### Single-Ended WATROD

- Watt densities up to 45 W/in<sup>2</sup> (6.9 W/cm<sup>2</sup>)
- UL® and CSA component recognition up to 240VAC
- Alloy 800/840 and stainless steel sheath temperatures up to 1200°F (650°C)

#### Double-Ended WATROD

- Watt densities up to 120 W/in<sup>2</sup> (18.6 W/cm<sup>2</sup>)
- UL® and CSA component recognition up to 600VAC
- Alloy 800/840 sheath temperatures up to 1600°F (870°C)
- Stainless steel sheath temperatures up to 1200°F (650°C)
- Steel sheath temperatures up to 750°F (400°C)
- Alloy 800 sheath temperatures up to 1800°F (982°C)

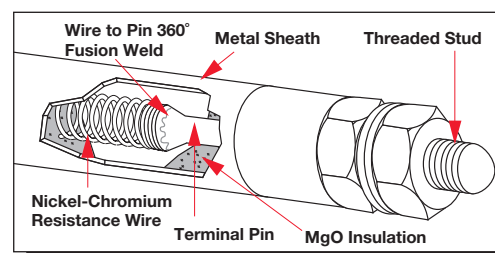
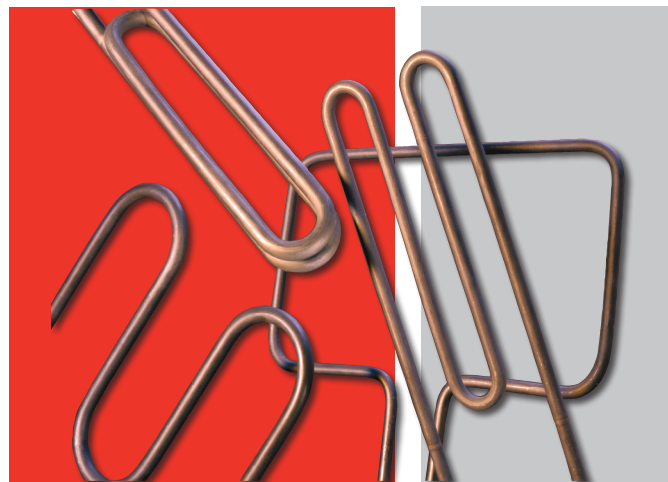

### Features and Benefits

#### Precision wound nickel-chromium resistance wire

- Distributes heat evenly to the sheath for optimum heater performance

#### Silicone resin seals

- Protects against moisture contamination and is rated to 221°F (105°C)

#### MgO insulation filled sheath

- Maximizes dielectric strength, heat transfer and life

#### Standard sheath materials

- Steel, 304 and 316 stainless steel, alloy 800/840 and alloy 600

#### 53 standard bend formations

- Allows forming the heating element to the application. Spirals, compound bends and multi-axis and multi-plane configurations available

#### Stainless steel studs

- Fusion welded to terminal pins for mechanical strength

**Popular termination, mounting and moisture seal options available, see heater catalog for details.**



## Options

### Moisture Resistant Seals

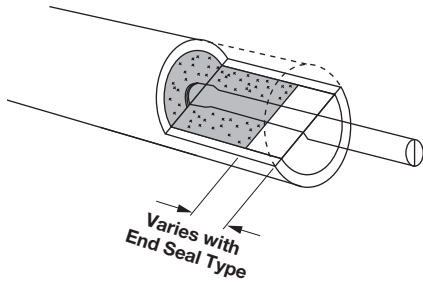

WATROD's MgO insulating material is hygroscopic. To control the rate of moisture entering the heater, an appropriate moisture seal must be used. Choosing the correct seal is important to the life and performance of the heater. All materials have varying rates of gas vapor transmission. Be sure the maximum continuous use temperature is not exceeded at the seal location. Most end seals are applied with a small cavity in the end of the heater. The seal will also help prevent arcing at the terminal ends.

### Zoned Heaters

Only single zone heaters are available.

### External Finishes

#### Bright Annealing

Bright annealing is a process that produces a smooth, metallic finish. It is a special annealed finish created in a non-oxidizing atmosphere. This finish is popular in the pharmaceutical and food and beverage markets.

To order, specify **bright annealing**.

#### Passivation

During the manufacturing process, particles of iron or tool steel may become embedded in the stainless steel or alloy sheath. If not removed, these particles may corrode, produce rust spots and/or contaminate the process. For critical sheath applications, passivation will remove free iron from the sheath.

To order, specify **passivation**.

### Ceramic-to-Metal End-Seal

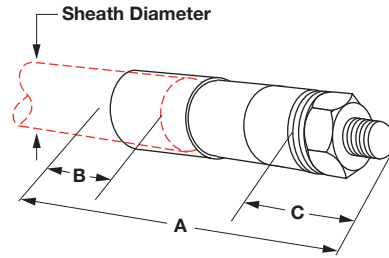

Ceramic-to-metal end-seals with threaded stud terminations provide an air-tight seal for continuous terminal temperatures up to 500°F (260°C). Watlow does not recommend this seal if terminations are exposed to temperatures exceeding 500°F (260°C).

Sheath Diameter	A	B	C	Thread Size
in. (mm)	in. (mm)	in. (mm)	in. (mm)	
0.260 (6.6)	1 11/16 (42.9)	1/2 (13)	13/32 (10.32)	#8-32
0.315 (8.0)	1 7/8 (47.6)	1/2 (13)	13/32 (10.32)	#10-32
0.430 (10.9)	2 1/8 (54.0)	1/2 (13)	13/32 (10.32)	#1/4-28

### End-Seal Options

End-Seal	Part Number	Color	UL® Recognition	Max. Cont. Use Temperature	Typical or General Usage/Application
Standard Epoxy	<b>EC</b>	Cream	Yes	194°F (90°C)	Long term stable insulation resistance
Intermediate Epoxy	<b>EB</b>	Gray	Yes	356°F (180°C)	Long term stable insulation resistance
High-Temp. Epoxy	<b>HTE</b>	Amber	No	450°F (232°C)	Long term stable insulation resistance
Silicone Resin	<b>SR</b>	Clear	Yes	221°F (105°C)	General usage on tubular products - porous
Silicone Fluid	<b>SF</b>	Clear	No	392°F (200°C)	Moisture resistance of the MgO, or high temperature ceramic seal (storage only) - porous
Lavacone	<b>LC</b>	Dark Brown	Yes	221°F (105°C)	Porous seal for the FIREBAR
Silicone Rubber RTV	<b>RTV</b>	Red-Orange	Yes	392°F (200°C)	General usage on FIREBAR applications - porous
High-Temperature Ceramic	<b>HTC</b>	White	Yes	2800°F (1538°C)	Very high-temperature applications - for extremely low vapor transmission rate

## Terminations

### Terminations

Double-ended WATROD elements are available with a variety of terminations. Single-ended WATROD elements are available with only flexible lead wires.

The following table and illustrations detail the terminations available with double- or single-ended WATRODs—for each available sheath diameter.

Flexible lead wires are 12 in. (305 mm), Sil-a-Blend® 390°F (200°C) unless otherwise specified. Insulation options include TGGT 480°F (250°C) plus other temperature ratings. Contact a Watlow representative.

Overmolds are available for flexible lead wires only. Available in silicone rubber 390°F (200°C) and neoprene 212°F (90°C). Contact a Watlow representative.

WATROD Element	Sheath Diameter in. (mm)		Threaded Stud <sup>①</sup>	Screw Lug (Plate)				Quick Connect (Spade)			Flexible Lead Wires
			A	B	C	D	E	F	G	H	
Double-Ended	0.260	(6.6)	#6-32	Yes	Yes	Yes	Yes	Yes	Yes	Yes	Yes
	0.315	(8.0)	#10-32	Yes	Yes	Yes	Yes	Yes	Yes	Yes	Yes
	0.335	(8.5)	#10-32	Yes	Yes	Yes	Yes	Yes	Yes	Yes	Yes
	0.375	(9.5)	#10-32	Yes	Yes	Yes	Yes	Yes	Yes	Yes	Yes
	0.430	(10.9)	#10-32	Yes	Yes	Yes	Yes	Yes	Yes	Yes	Yes
	0.475	(12.1)	#10-32	Yes	Yes	Yes	Yes	Yes	Yes	Yes	Yes
	0.490	(12.5)	#10-32	Yes	Yes	Yes	Yes	Yes	Yes	Yes	Yes
Single-Ended	0.375	(9.53)	No	No	No	No	No	No	No	No	Yes
	0.430	(10.9)	No	No	No	No	No	No	No	No	Yes
	0.475	(12.1)	No	No	No	No	No	No	No	No	Yes
	0.490	(12.5)	No	No	No	No	No	No	No	No	Yes

## Bend Formations (See Heater Catalog for more details)

### Double-Ended WATROD

Double-ended WATROD heating elements can be formed into spirals, compounds, multi-axis and multi-planes from 36 common bend configurations. Custom bending with tighter tolerances can be made to meet specific application needs.

Formation is limited by the minimum bend radius (R) and the straight length (F) required beyond the bend. In order to locate the end of a heated length within a bend, the radius must be 3 in. (76 mm) or larger. Additionally, overall length tolerance (T) must be included in one or more of the straight lengths.

### Single-Ended WATROD

Watlow does not recommend field bending single-ended WATROD elements. Formation is limited by the minimum radius of a bend (R) and the straight length (F) beyond the bend. The radius must be 3 in. (75 mm) or more for the heated length's end to be inside a bend.

Additionally, the overall length tolerance (T) must be provided for in one or more of the specified lengths.

## Mounting Methods

### Brackets - Standard Shown

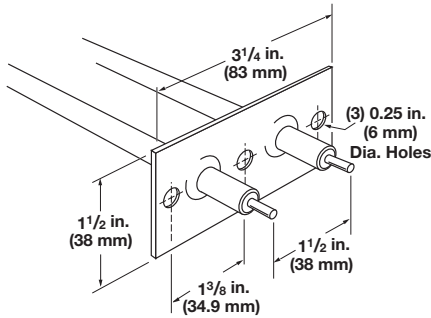

A 0.065 in. (1.7 mm) thick stainless steel bracket provides element mounting in non-pressurized applications. Attached to the heater sheath, these brackets are not suited for liquid-tight mountings. The bracket is located 1/2 in. (13 mm) from the sheath's end, unless otherwise specified.

### Single Leg Bracket - Standard

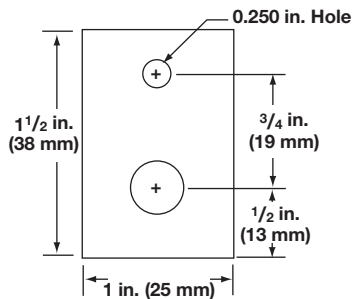

A 1 1/2 in. (38 mm) x 1 in. (25 mm) wide x 16 gauge stainless steel bracket with one element hole and one mounting hole 1/2 in. (13 mm) from end.

### Locator Washers

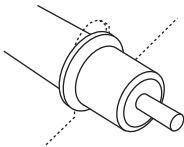

Stainless steel locator washers retain the heated area of the sheath in the work zone, while allowing for expansion and contraction during cycling.

### Mounting Collars

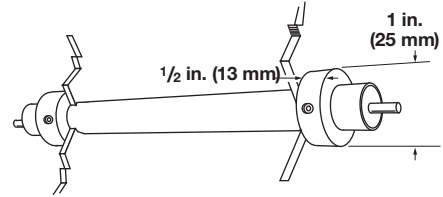

Plated steel mounting collars secure the heater sheath with set screws to serve as adjustable stops for through-the-wall mounting. Collars are shipped in bulk.

### Threaded Bulkheads

A threaded bushing with flange on the heater sheath provides rigid, leak-proof mounting through the walls of tanks. A gasket, plated steel washer and hex nut are included. The threaded end of the bushing is flush with the sheath's end unless otherwise specified. Threaded bulkheads are available in brass, steel or stainless steel.

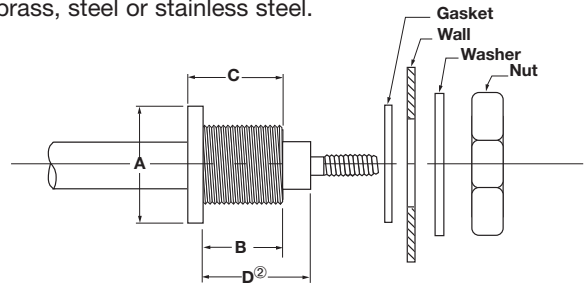

### Options - Extended Capability

See the current heater catalog for detailed information on extended capabilities.

Watlow® and FIREBAR® are registered trademarks of Watlow Electric Manufacturing Company.  
 MULTICOIL™ and WATROD™ are trademarks of Watlow Electric Manufacturing Company.  
 UL® is a registered trademark of Underwriter's Laboratories, Inc.  
 Sil-a-Blend® is a registered trademark of Radix Wire Company.

To be automatically connected to the nearest North American Technical Sales Office:  
**1-800-WATLOW2 • www.watlow.com • inquiry@watlow.com**

International Technical Sales Offices: Australia, +61 3 9335 6449 • China, +86 21 3532 8532 • France, +33 1 41 32 79 70  
 Germany, +49 (0) 72 53 / 94 00-0 • India, +91 40 6661 2700 • Italy, +39 024588841 • Japan, +81 3 3518 6630 • Korea, +82 2 2628 5770  
 Malaysia, +60 3 8076 8745 • Mexico, +52 442 217 6235 • Singapore, +65 6773 9488 • Spain, +34 91 675 12 92  
 Taiwan, +886 7 288 5168 • United Kingdom, +44 (0) 115 964 0777